

Other Designs of Flat Fan Nozzles

Illu. 1

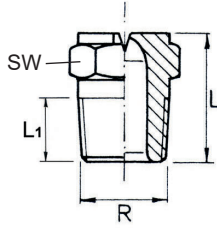

Illu. 1 Type F
Short flat fan nozzles

Thread R	L	L1	SW
1/16"	12.5	4.5	8
1/8"	17.5	7	11
1/4"	18	10	14
3/8"	19	10	17

Illu. 3

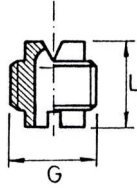

Illu. 4

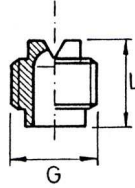

Illu. 3 and 4 Type FGE
Screw-in nozzles as grub screw

Illu. 3 With slot to be screwed in from behind
Illu. 4 With flat in front

On request

Illu. 5

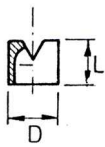

Illu. 6

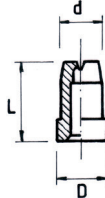

Illu. 7

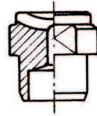

Impact flat fan nozzles

Illu. 5 Type FE made from stainless steel
Illu. 6 Type FES made from all materials
Illu. 7 Type FH made from stainless steel

On request

Illu. 8

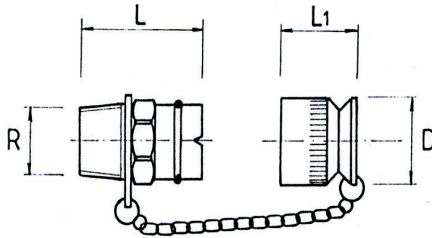

Illu. 9

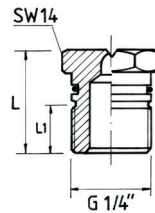

Illu. 8 Type FLB
Fire protection flat fan nozzles
with protective cap and clip chain

On request

Illu. 9 Type FO
Flat fan nozzles with O-ring seal

Illu. 10

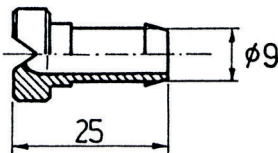

Illu. 11

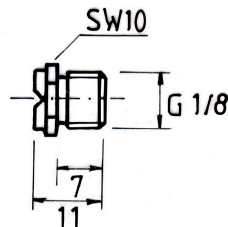

Illu. 10 Type FSS
Flat fan nozzles with tube connection

On request

Illu. 11 Type FM
Smallest possible, 1/8" flat fan nozzles

Different threads available on request!

Illu. 12

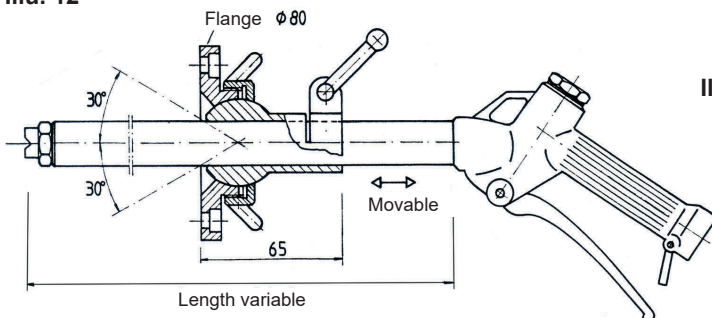

Illu. 12 Pivoting cleaning lance SRL

Please request more information!