

Characteristics

When the medium leaves the propellant nozzle, it causes negative pressure inside of the injector mixing nozzle's inlet cone. In this process, the liquids are sucked in from the container, and spread evenly and homogeneously in the container in a three-dimensional manner.

Application

Fluid stirring and mixing,
 Suspension stripping,
 Keeps dissolved parts in fluids from sinking,
 Fluid heating by means of steam,
 Fluid aerating,
 Feeding gases into fluids (CO₂)

Material

Stainless steel
 Plastic, PP

Illu. 1 - Diagram of functions

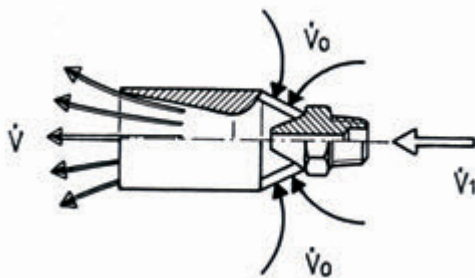

\dot{V}_1 = Flow rate of pump resp. saturated steam output
 \dot{V}_0 = 4-fold suction effect
 \dot{V} = 5-fold outlet

Dimensions

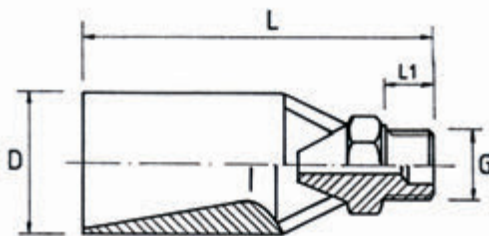

Female thread available in stainless steel,
 in PP available on request

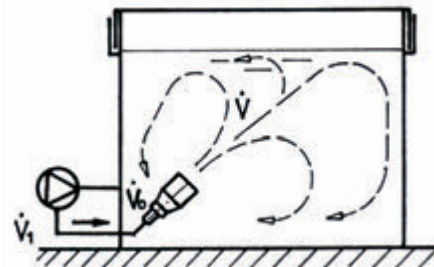

Three-dimensional
 liquid distribution

Type Thread	Ø (mm)	Flow rate \dot{V}_1 (l/min.) at pressure p (bar)					Saturated steam capacity \dot{V}_1 in kg/h at pressure p (bar)					Compressed air capacity \dot{V}_1 (Nm ³ /h) 20° C at pressure p (bar)					Material		Dimensions in mm		
		bar 1	bar 2	bar 3	bar 4	bar 5	bar 1	bar 2	bar 3	bar 4	bar 5	bar 1	bar 2	bar 3	bar 4	bar 5	PP	VA	D	L	L1
J 3/8"	7.5	34	48	59	68	76	49	74	98	123	147	42	63	84	105	126	*	*	48	100	10
J 1/2"	8.0	45	65	80	92	100	54	81	108	135	162	69	103	138	172	207	*	*	48	100	13
J 3/4"	10.0	63	89	109	125	141	84	126	168	210	255	107	161	214	267	322	*	*	60	130	20
J 1"	11.0	80	115	140	161	180	102	153	204	255	306	130	195	260	325	390	*	*	80	140	20
J 1 1/4"	13.0	113	162	197	224	253	142	215	286	358	430	182	273	365	453	545	*	*	90	200	22
J 1 1/2"	15.0	150	220	270	310	350	190	285	380	475	570	242	364	485	605	725	*	*	106	245	22
J 2"	21.0	295	432	530	609	687	372	558	745	931	1,117	474	582	951	1,186	1,460	*	*	118	255	24
J 3"	30.0	600	878	1,077	1,238	1,396	760	1,140	1,520	1,900	2,280	968	1,456	1,940	2,420	2,900	*	*	132	300	30

Intermediate sizes available on request!

All flow rates listed are approximates depending on the container's counter-pressure. Please contact us for more information.

Mini-Injector Mixing Nozzle JM

MC

For small flow rates or small baths

Characteristics and application correspond to type; design in additional materials possible, such as:

Brass
Stainless steel
PVC
PP
PVDF
Teflon

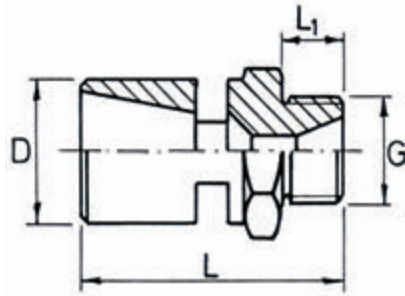

Type JM Dimensions

Type	Ø (mm)	Flow rate V1(l/min.) at pressure p (bar)					Saturated steam capacity V1 in kg/h at pressure p (bar)					Compressed air capacity V1 (Nm³/h) 20° C at pressure p (bar)					Thread G	Dimensions in mm			
		bar 1	bar 2	bar 3	bar 4	bar 5	bar 1	bar 2	bar 3	bar 4	bar 5	bar 1	bar 2	bar 3	bar 4	bar 5		SW	L	L1	D
JM 1/8"	1.2	0.7	1.0	1.2	1.4	1.6	1.4	2.1	2.7	3.4	4.1	1.5	2.3	2.1	3.8	4.6	1/8"	14	22	6	14
JM 1/4"	2.0	1.8	2.6	3.2	3.7	4.0	3.4	5.1	6.7	8.4	10.1	4.3	6.5	8.6	10.7	12.9	1/4"	17	30	7	17
JM 3/8"	3.5	6.5	9.5	11.5	13.2	15.0	10.3	15.5	20.6	25.7	30.9	13.2	19.8	26.4	33.0	39.6	3/8"	19	35	8	19
JM 1/2"	5.0	15.0	22.0	27.0	31.1	34.8	21.0	31.5	42.0	52.5	63.0	26.8	40.2	53.5	63.5	80.2	1/2"	24	46	9	24
JM 3/4"	6.0	23.1	32.6	40.0	46.0	51.6	30.4	45.6	60.8	76.0	91.0	32.5	48.7	65.0	81.2	97.5	3/4"	32	60	10	32

Intermediate sizes available on request!

Other mini-injector variants

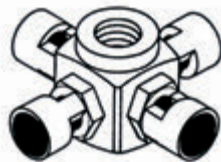

Type **JM-4**
4-fold injector
V1 = 4-fold table value,
Dimensions on request

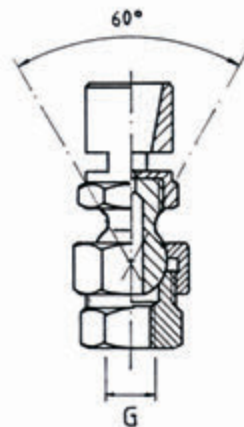

Type **JM-S**
with ball joint
Swivel range 60° all around,
Dimensions on request

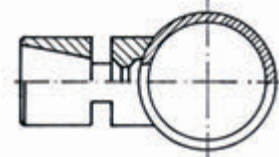

Type **JM-M**
made from PVC for direct
adhesive bonding to PVC pipes
(especially for galvanization),
Dimensions on request

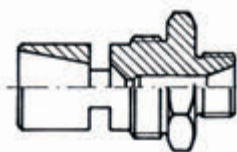

Type **JM-K**
with head thread
to be screwed into
container's external wall,
Dimensions on request

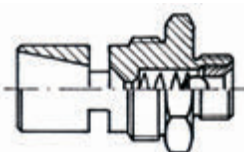

Type **JM-KR**
with head thread
and integrated check valve,
Dimensions on request

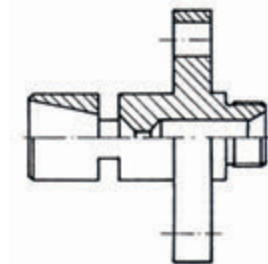

Type **JM-F**
with flange connection
to flange to in- or
outside of container,
Dimensions on request

Liquid jet pumps for transportation and metering of liquids

MC's liquid jet pumps type **JP** are injector pumps without flexible parts. Liquid is injected from the propellant nozzle into the diffuser at high velocity, so that negative pressure arises inside of the injector head, and a second liquid is sucked in and mixed.

Function diagram

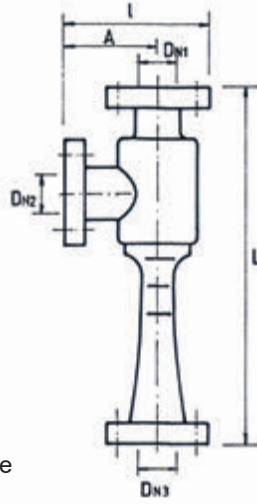
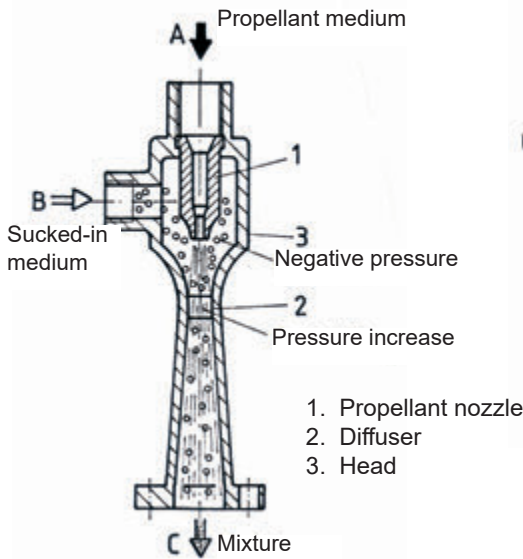

Type JP with flange connection (see tables)

Request comparative performance tables!

Type	Dimensions in mm				Max. mixture flow M in kg/h
	L	DN1	DN2	DN3	
JPA	140	15	10	15	500
JPB	190	20	20	20	1,200
JPC	220	25	20	25	2,000
JPD	280	32	20	32	3,500
JPE	325	40	25	40	6,000
JPF	480	50	32	50	12,000
JPG	570	65	40	65	25,000
JPH	650	80	65	100	50,000

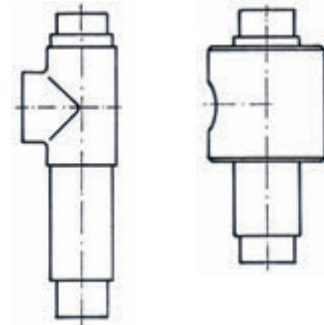

Made from PVC for adhesive bonding and screwing. Request technical data!

Liquid Jet Gas Compressor JV

Liquid jet gas compressor for suction of air/gas by means of a liquid jet

MC's liquid jet compressor type **JV** creates without flexible parts a vacuum for air or gas compression. Liquid is injected into a diffuser from an interchangeable full cone nozzle with narrow spray angle. Negative pressure arises inside of the injector head and leads to the suction and deposit of air or gas.

Function diagram

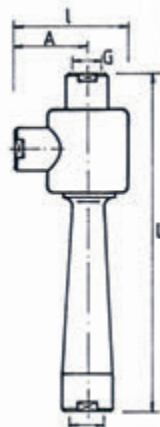
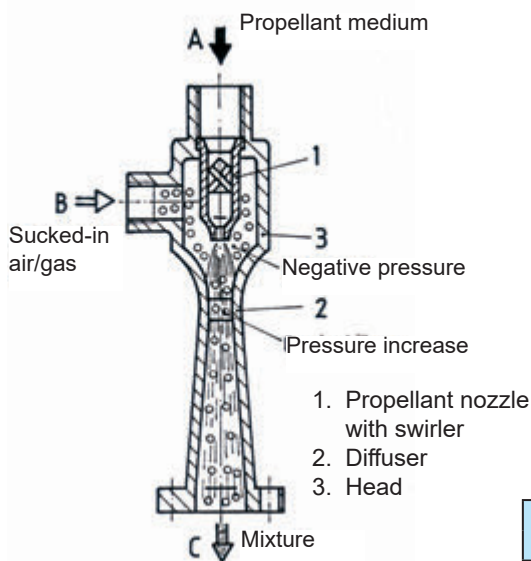

Type JVP with thread connection

Request design data!

Type	Dimensions in mm				
	G	G1	G2	L	A
JVP0	1/2"	1/2"	1/2"	240	65
JVP1	3/4"	1/2"	1/2"	260	70
JVP2	1"	3/4"	3/4"	310	80
JVP3	1 1/2"	1"	1"	405	105

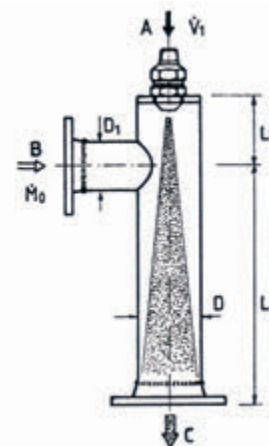

Example for pipe integration with full cone nozzle type VP and head thread (see page 3.7 and 3.8)

We design according to your dimensions!

Function diagram

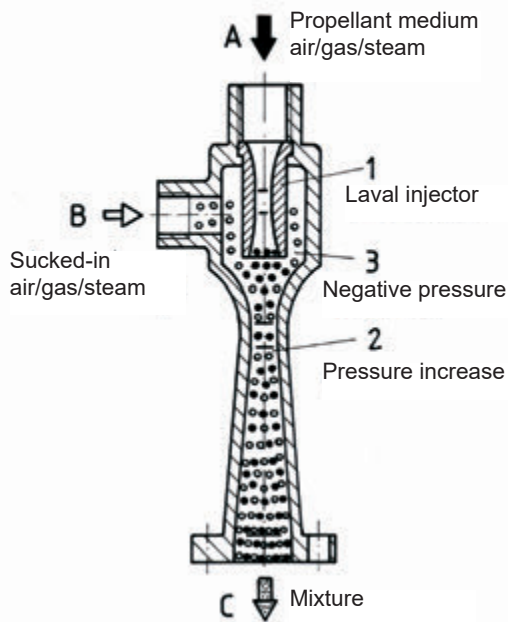

Air/gas jet pumps help to create a vacuum. They are also used for gas compression and mixing purposes. Compressed air or gas/steam serves as propellant medium.

Steam jet vacuum pump
 Steam jet liquid pump
 Steam jet compressor

The steam jet's velocity is often a multiple of the velocity of sound. Thus, large volumes are processed.

To utilize steam jet pumps correctly in process engineering, their special characteristics have to be brought in line with engineering's conditions.

Advantages:

- no flexible parts
- large suction flows possible
- little maintenance necessary
- long service life
- operationally reliable
- low operating costs when utilized correctly
- design in various materials possible

Hot Water Station JH

MC's hot water station **JH** is an appliance which heats liquids with the help of steam to max. 90°C. The entire steam energy is given off to the liquid.

No pre-heating necessary, hot water is available right away.

It comes with sliders, thermostates and injector pumps for cleaner dosing if requested.

Type	L	G1	G2	*Warm water capacity
JH 1	230	3/4"	1"	50 l/min.
JH 2	270	1"	1 1/4"	80 l/min.

* varies with water and heating steam throughput, larger sizes available on request

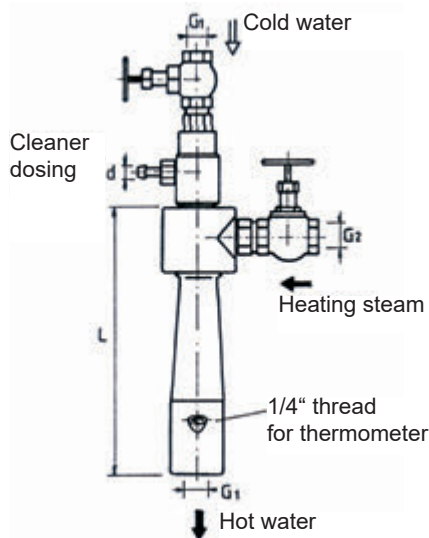

Choose from stations with a hot water capacity from 50 - 3,000 l/min.

Request further data!

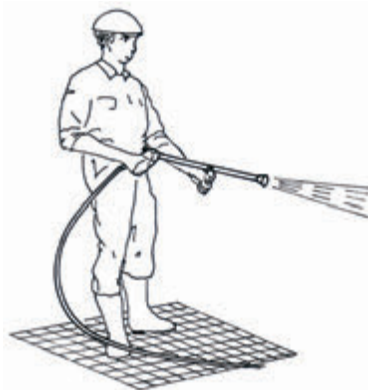

Manual cleaning with hand lance

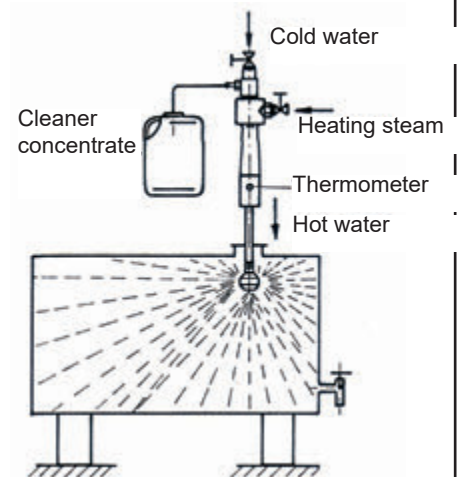

In connection with MC's tank cleaning nozzles, tank systems can be purified bacteriologically clean.

Check valve

Spring-loaded MC-check valves **RV** keep the pipes from emptying and prevent dripping when the nozzle is turned off. The pressure inside of the pipeline remains constant at the same time. Opening pressure is at 0.35 - 0.7 resp. 1.0 bar, depending on the spring.

Illu. 1

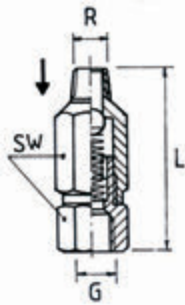

Type RV - IA

Illu. 2

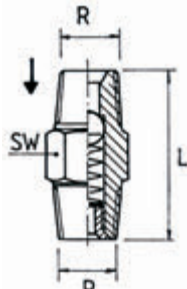

Type RV - AA

Materials: brass, stainless steel

Thread R+G	Max. flow rate at 3 bar
1/8"	2 l/min.
1/4"	8 l/min.
3/8"	16 l/min.
1/2"	25 l/min.

Needle valve N

MC-needle valves **N** regulate the max. flow rate of fluids or gases inside of the nozzles. They come with or without fine-tuning scale.

Illu. 3

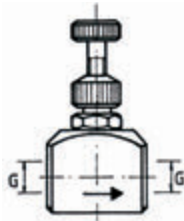

Illu. 4

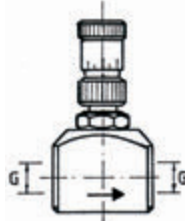

G 1/8" - 1/4" - 3/8"

Materials: brass, stainless steel

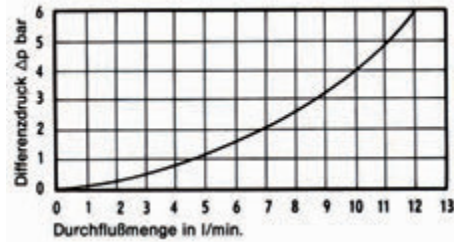

Fluid pressure valve DV

Illu. 5

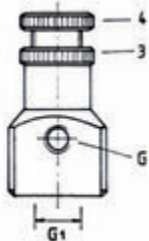

The valve is opened and closed by regulating the fluid pressure. The opening pressure can be adjusted with the help of collar set screw (4) and countered with screw (3). Closing pressure 0.5 - 1 bar below opening pressure. Max. pressure = 8 bar

Capacity: Size 1 1-20 l/min. at 3 bar, G = 1/8" - 1/4"
Size 2 5-40 l/min. at 3 bar, G1 = 3/8"

Combination valve VLM

The MC-combination valve **VLM** is an angle valve for alternate flow of fluid and compressed air. Fluid is pressed out of the pipes with the help of compressed air, preventing dripping or discharging of parts.

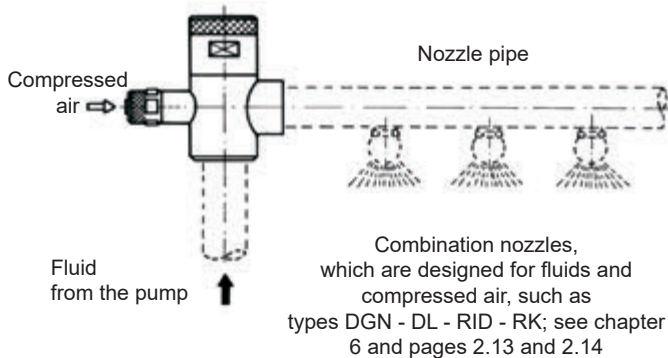

Materials: Fluid-leading parts made from stainless steel, NBR-seals

Liquid connection max. flow rate V bei 3 bar		Variation possibilities
1/2" 88 l/min.	3/4" 181 l/min.	Rinsing, washing and compressed air blow-off
1" 282 l/min.	1 1/4" 410 l/min.	Washing and rinsing with drip-stop through pipe blow-out
	1 1/2" 577 l/min.	

Accessories: manometer, by-pass lines, etc. - available on request

Various connection variations!

Fluid pressure or compressed air needle valve nozzles GV

MC calculates, designs and manufactures various needle valve nozzles, which suit your requirements. They are used for dispensing, injecting or marking purposes. Needle valve nozzles can either be controlled by fluid pressure or external energy.

- A Nozzle (of choice)
- B Connection
- C Adjusting opening pressure
- D Fine-tuning of flow rate, with or without scale

Illu. 1

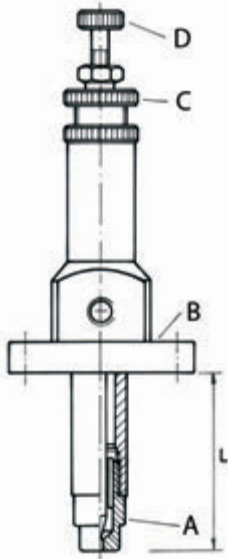

With flange connection

Type **GV**

Illu. 2

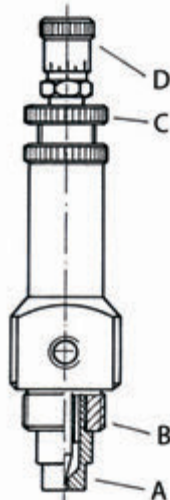

With head thread and fine-tuning scale

Type **GVK**

Illu. 3

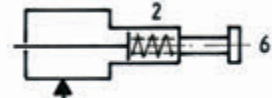

Option A 1

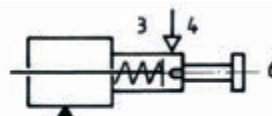

Option A 2

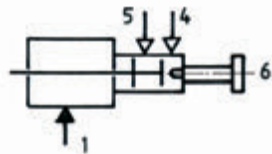

Option P 1

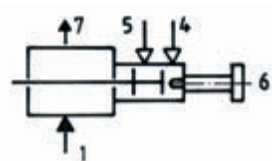

Option P 2

Controlling needle valve nozzles

1. Fluid feed
2. Compression spring; needle closes when fluid feed is stop ped
3. Compression spring; opens needle
4. Control air - needle is closed
5. Control air - needle is open
6. Regulating and shut-off needle
7. Fluid excess return

see page 10.4 for further specifications

Illu. 4

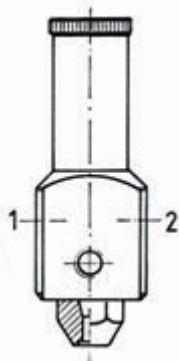

Type **GV-P**
Solid stream nozzle with pneumatic control

1. Fluid
2. Control air

Illu. 5



Type **GV-E**

1. Solid stream nozzle with spring-loaded needle; opens through self-pressure
2. Lock nut
3. Opening pressure regulation
4. Flow rate regulation

Illu. 6

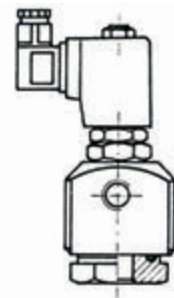

Type **GV-E**

Solid stream nozzle with electronic control